

各种规格型号剪板机上、下刀片系列

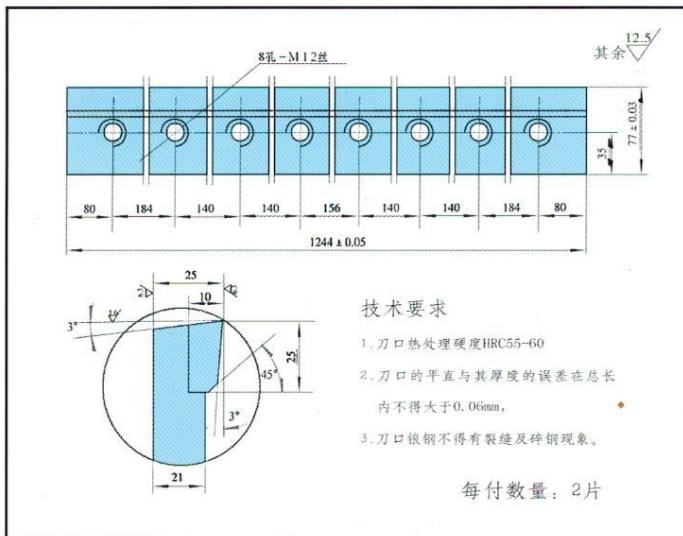

Q11-3 × 1200 剪板机刀片

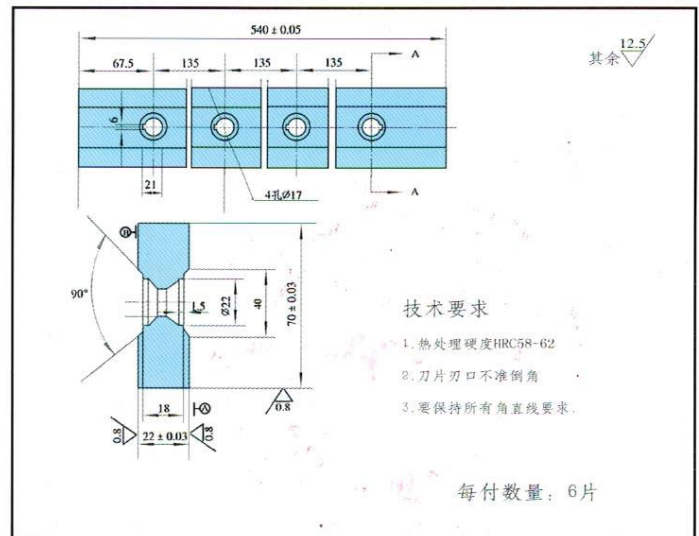

Q11-2.5 × 1600 剪板机刀片

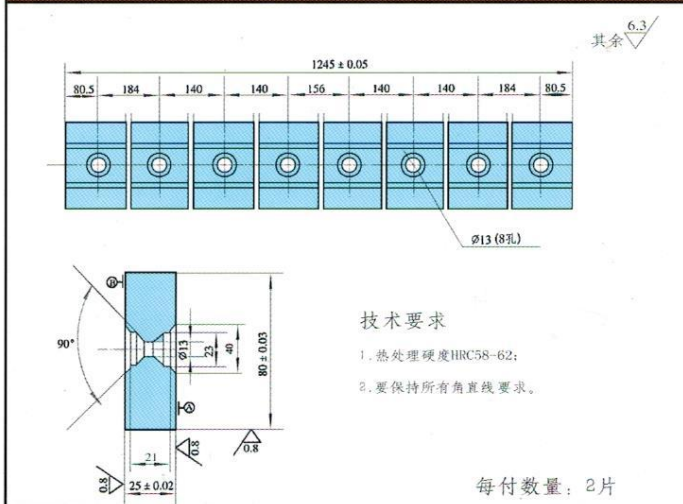

Q11-3 × 1200 剪板机刀片

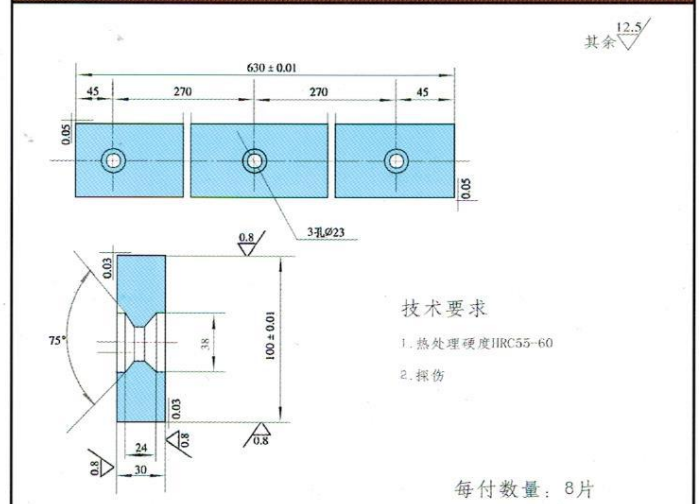

Q12-20 × 2500 剪板机刀片

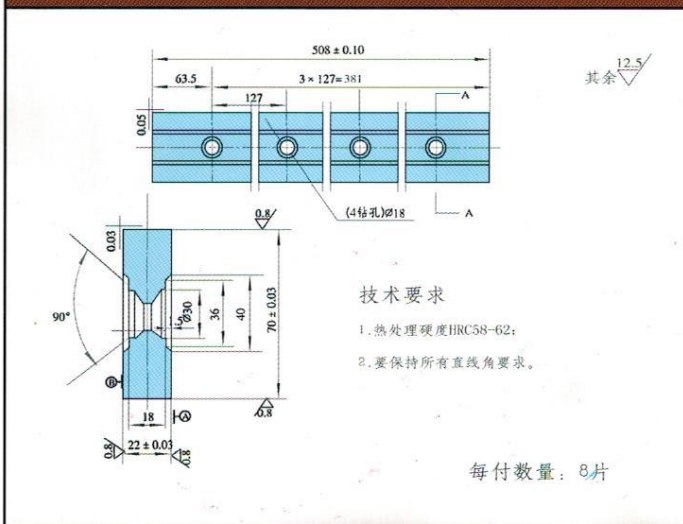

Q11-6.3 × 2000 剪板机刀片

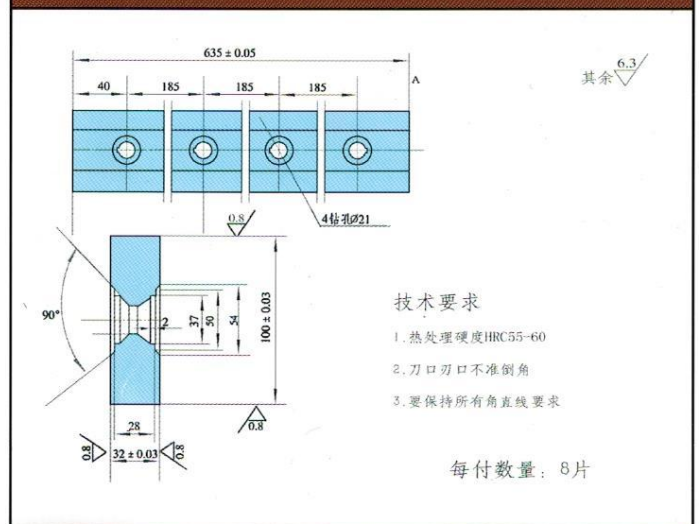

Q11Y-20 × 2500 剪板机刀片

各种规格型号剪板机上、下刀片系列

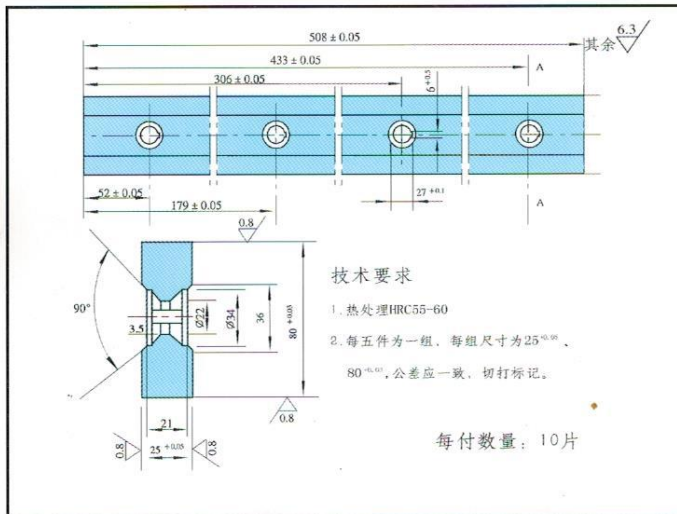

Q11-6 × 2500 剪板机刀片

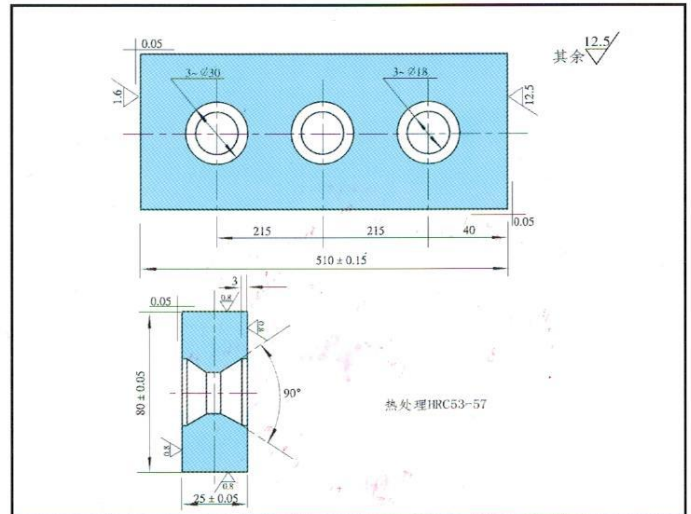

12 × 2000 剪板机刀片

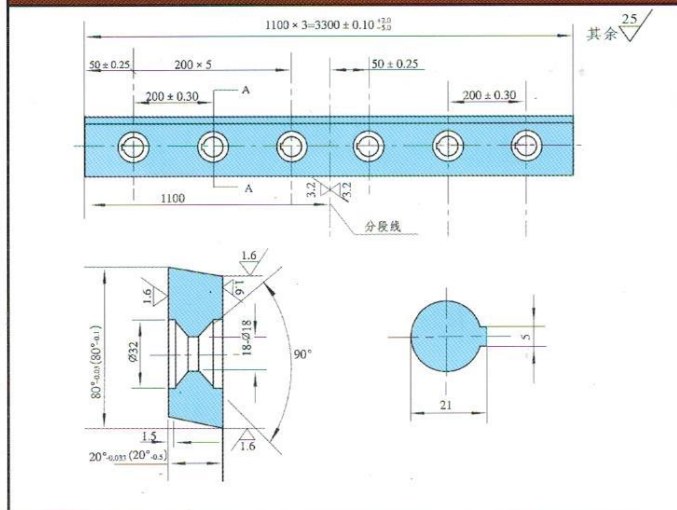

6 × 3200 剪板机上刀

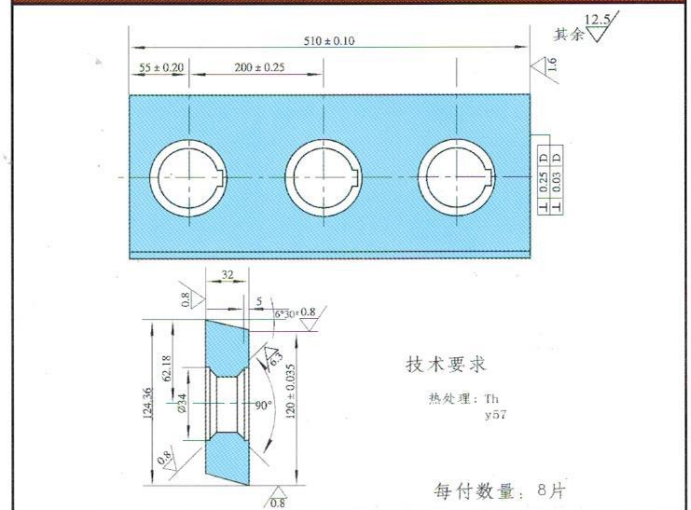

20 × 4000 剪板机上刀

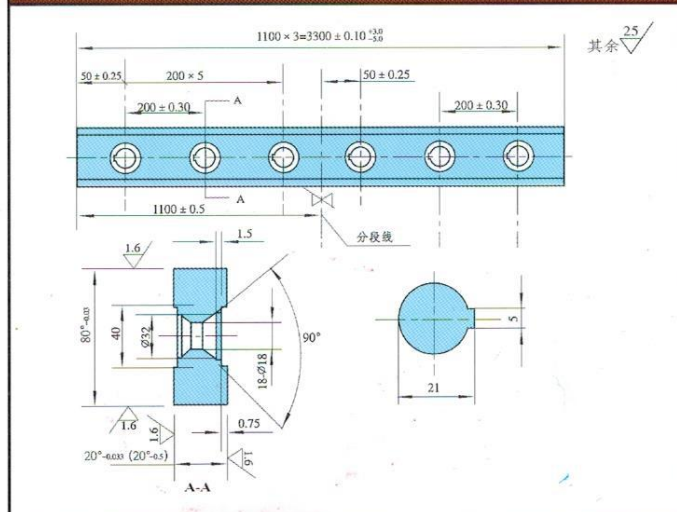

6 × 3200 剪板机下刀

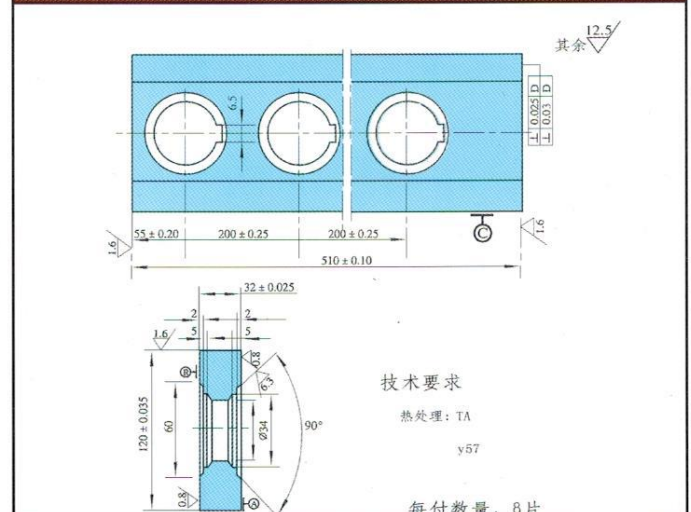

20 × 4000 剪板机下刀

各种规格型号剪板机上、下刀片系列

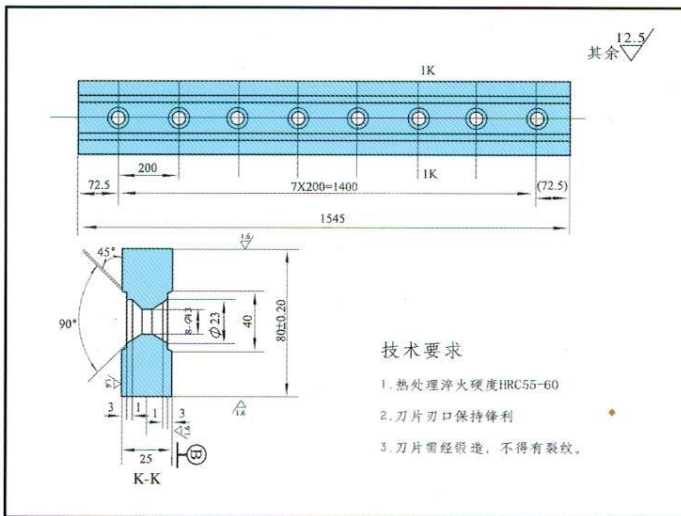

Q11-3 × 1500 剪板机刀片

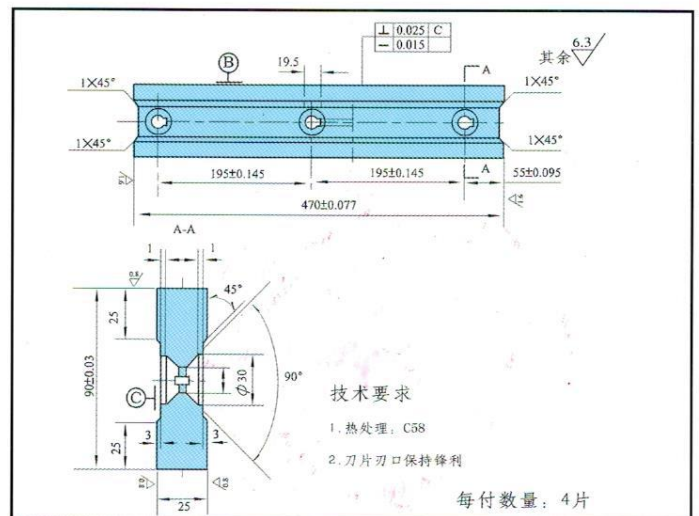

Q11-3 × 1800 剪板机刀片

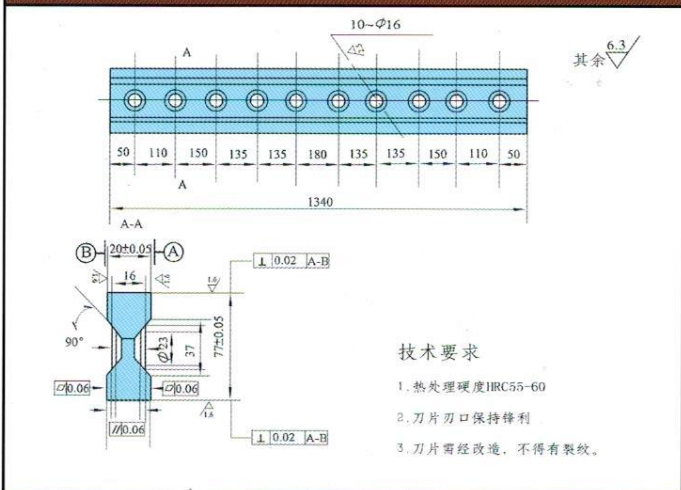

Q11-3.5 × 1300 剪板机刀片

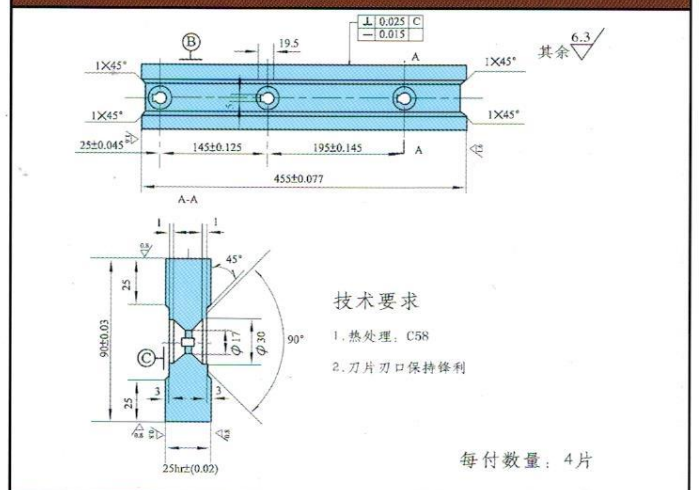

Q11-3 × 1800 剪板机刀片

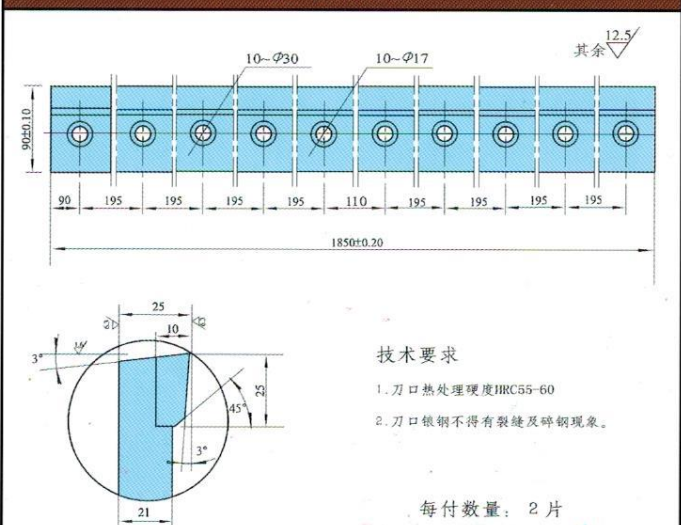

Q11-3 × 1800 剪板机刀片

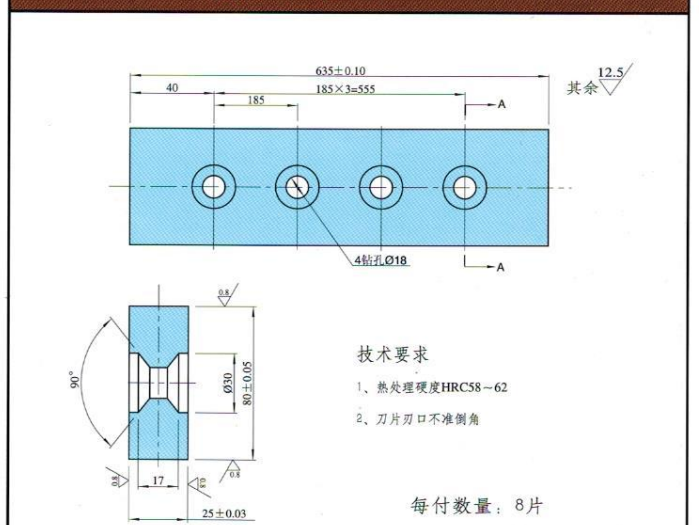

Q11-16 × 2500 剪板机刀片

各种规格型号剪板机上、下刀片系列

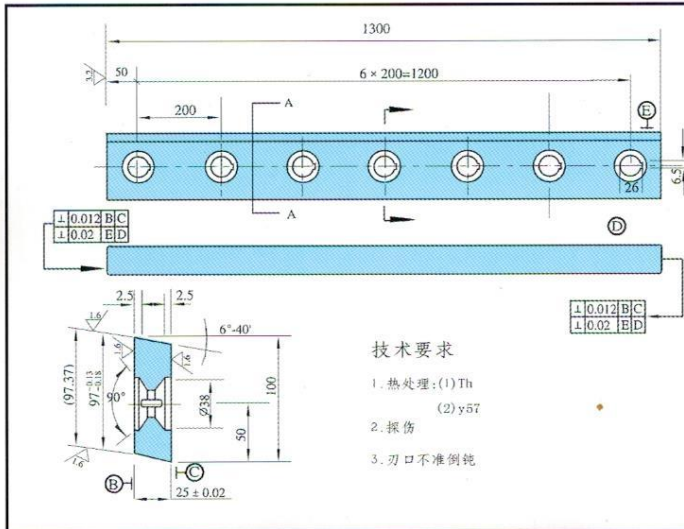

QC12Y-12 × 2500 剪板机上刀片

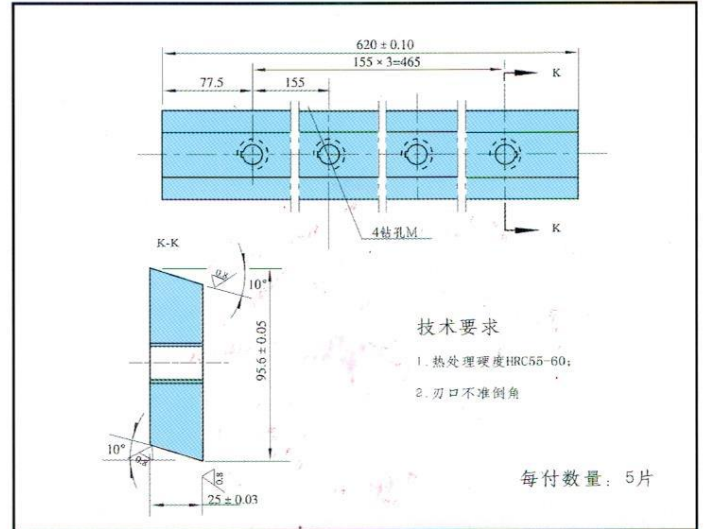

DLB-12 × 3050 剪板机上刀片

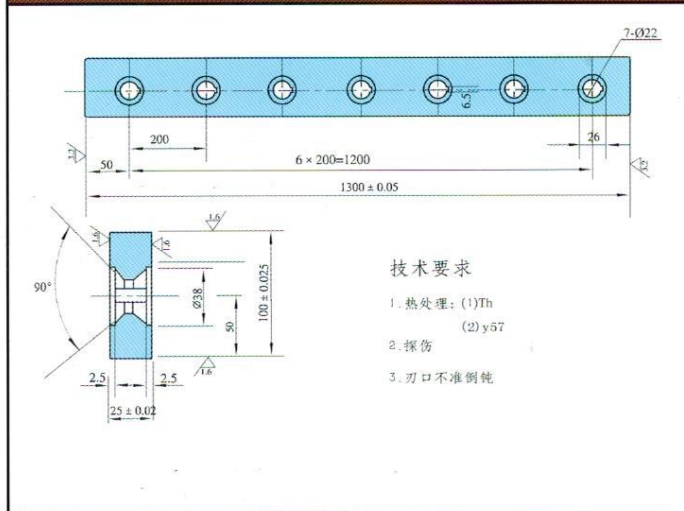

QC12Y-12 × 2500 剪板机下刀片

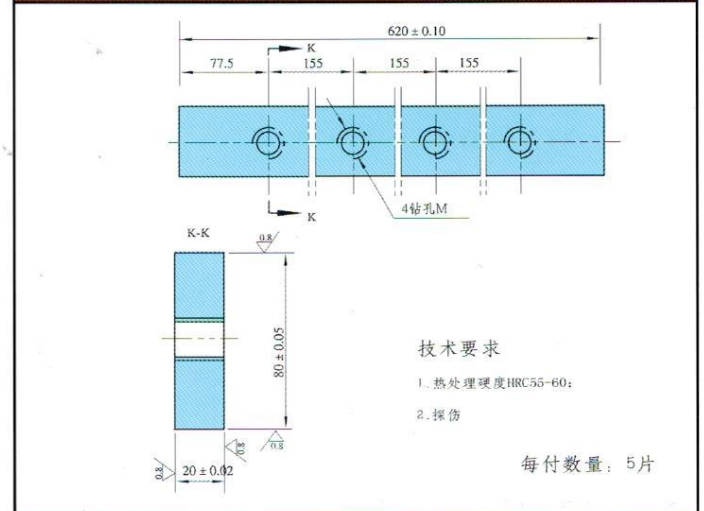

DLB-12 × 3050 剪板机下刀片

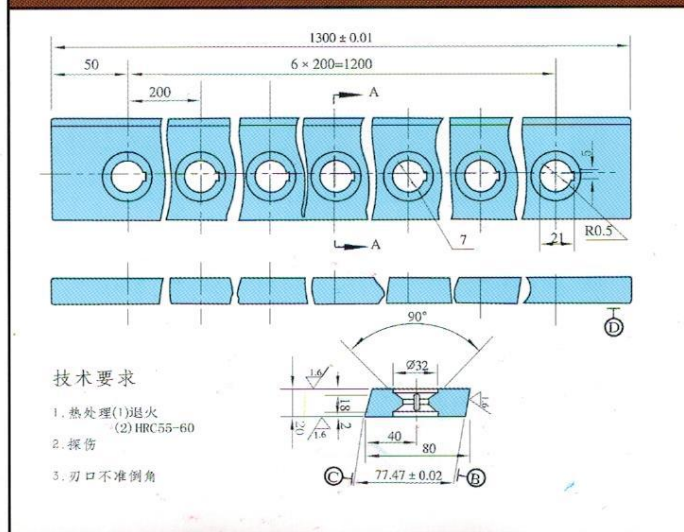

QC12Y-4 × 2500 剪板机刀片

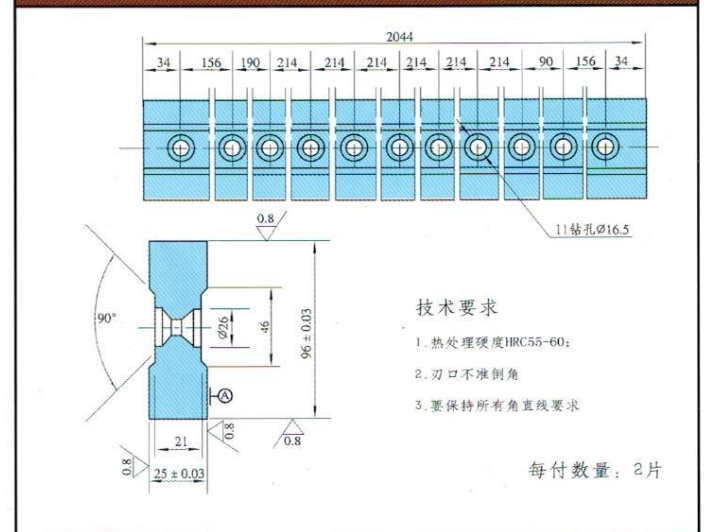

Q11-7 × 2000 剪板机刀片

各种规格型号液压摆式剪板机上、下刀片系列

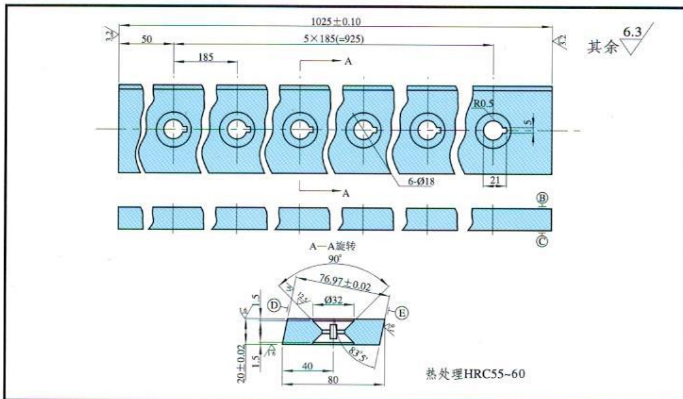

QC12Y-6 × 4000 液压摆式剪板机刀片

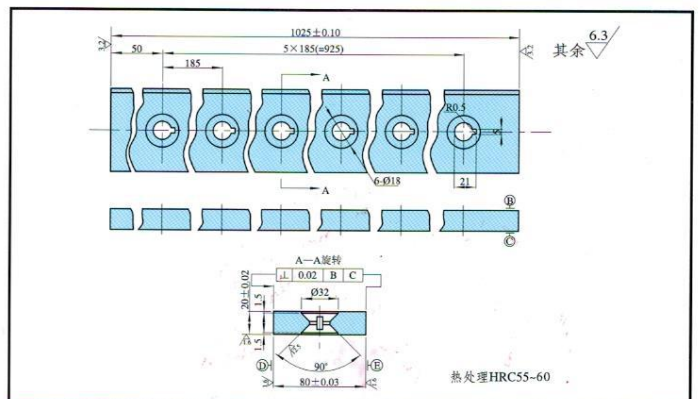

Q12Y-6 × 4000 液压摆式剪板机刀片

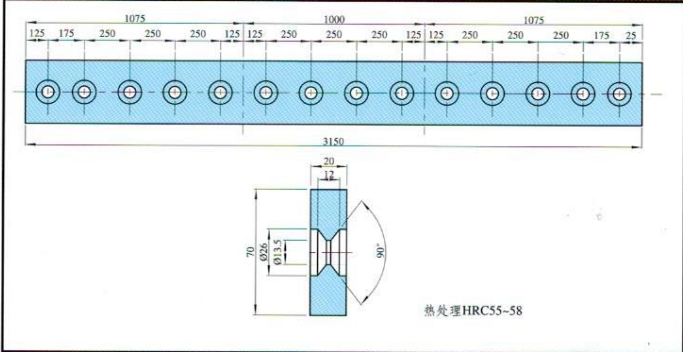

Q6.35 × 3100 剪板机刀片

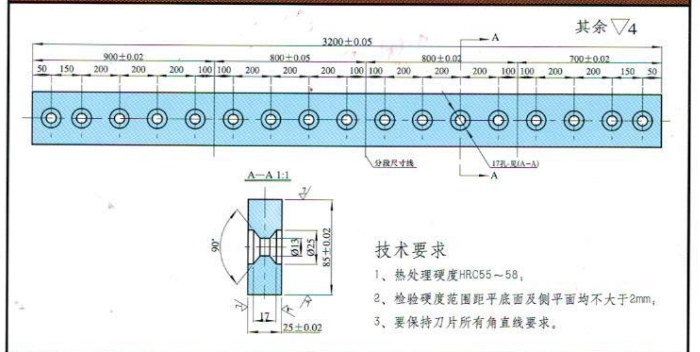

LVD-(HD)-13 × 3100 剪板机刀片

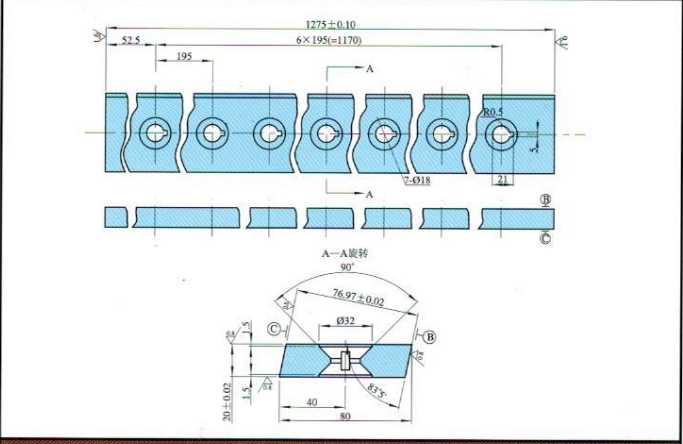

QC12Y-8 × 5000 液压摆式剪板机上刀片

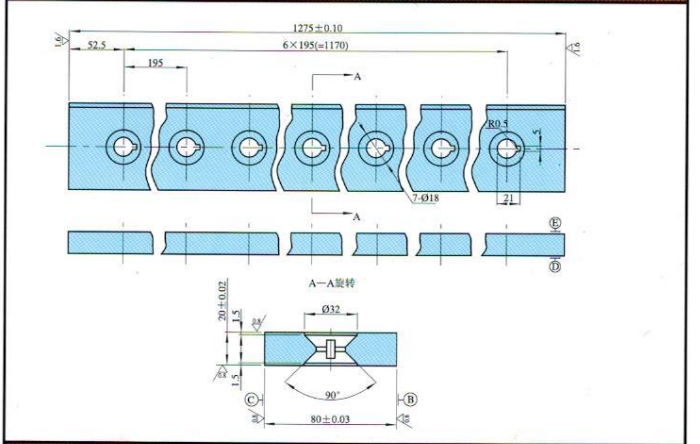

QC12Y-8 × 5000 液压摆式剪板机下刀片

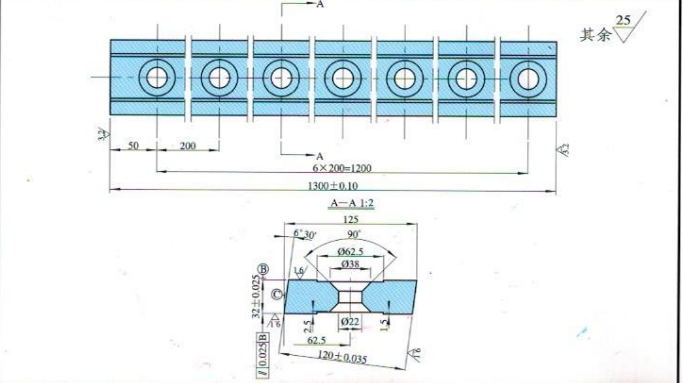

QC12Y-20 × 2500C 剪板机上刀片

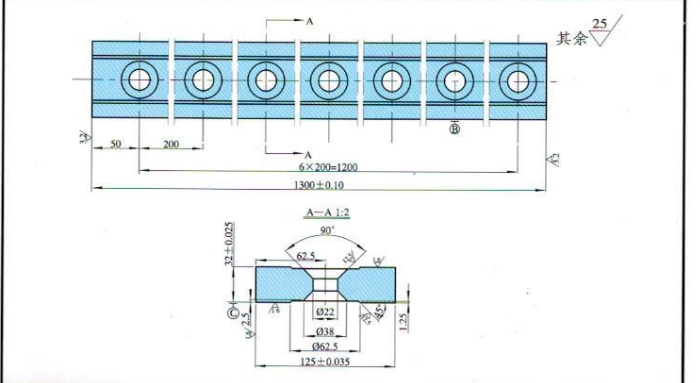

QC12Y-20 × 2500C 剪板机下刀片